

# Ci-HF11/12/21/22

## DH+ Optical Fiber Repeater(protocol type)

ShenZhen Comark Technology Co., Ltd.

Tel: 86-755-26055466

Fax: 86-755-22630031

Post : 518126

Addr: Floor 4, Building G, No. 2 Tangxi Industrial

Zone, No. 21, Xijing Road, Gu Shu, Xi Xiang, Bao'An

District, Shenzhen, 518126, P. R. China.

Website: <http://www.comark.cn>

### Summary

This series is designed for industrial grade A-B DH&DH+&Remote I/O Optical Fiber Repeater, support A-B DH&DH+&Remote I/O protocol, Support Dial switch for setting communication rate, Support 1~2 A-B DH&DH+&Remote I/O bus, according to A-B DH&DH+&Remote I/O Protocol. Support Redundancy optical fiber ring network, when fiber optic error somewhere, the system will rebuild the network link within 20ms, to guarantee the normal system communication, achieve the function of signal transmission self-healing protection, the system will recovery automatically after the network troubleshooting; this series products adopt Comark own R&D professional network protocol Ci-ring, no need any set, no need root knot, quickly finishing the network function of ring closing and ring opening, this series products can plug and play, no configuration, to simplify the user installation procedure at utmost. The product is Industrial grad designed, Casing: IP40 protection, wave grain aluminum reinforce case option, DIN rail mounting, DC(9~36v) power input, support optical fiber link failure and bus error alarm output, dual redundant power input and isolation protection. -40~75 °C Operating Temperature, can meet various Industrial situation.

### Characteristic

- Support 1~2 A-B DH&DH+&Remote I/O bus, according to A-B DH&DH+&Remote I/O Protocol
- Support 1~2 Fiber Optic Ports, ST connector ( SC, FC Optional)
- Support optical fiber link failure and bus error alarm output and LED indication
- Support Dial switch for setting communication rate
- Support Redundancy optical fiber ring network, solution cycle time < 20ms
- DC(9~36V) dual redundant power input, With DC1500V voltage isolation and reverse connect protection
- IP40 protection, Metal case (wave grain aluminum reinforce case option), 35mmDIN-Rail Installation
- Operating Temperature: -40°C to 75°C suitable to

various Industrial work situation

### Ring Network

DH+ bus Optical Fiber Repeater Networking topology can achieve the net link below: point to point communication, chain network, star network, redundancy dual networks and fiber optic ring network self-healing protection, etc. The product uses flexibly, can make up many kinds of fiber optic networks. Logically independent dual bus electric interface, can achieve electric interface backup or single equipment access dual redundancy bus system; adopt point to point network can achieve connecting two segments of DH+ by fiber optic; adopt dual optical ports chain-shaped network fiber optic bus achieve multi-network-segments DH+ connection (maximum 200 pcs); meanwhile, the product adopt dual optical ports to achieve the function of dual fiber ring network redundancy, when fiber optic error somewhere, the system will rebuild the network link within 20ms, to guarantee the normal system communication, achieve the function of signal transmission self-healing protection, the system will recovery automatically after the network troubleshooting; this series products adopt Comark own R&D professional network protocol Ci-ring, no need any set, no need root knot, quickly finishing the network function of ring closing and ring opening, this series products can plug and play, no configuration, to simplify the user installation procedure at utmost.

### Specification

#### Bus data interface

- Interface type: SER1、SER2 industrial terminal
- Support A-B DH&DH+&Remote I/O bus standard
- Baud Rates: 57.6Kbps, 115.2Kbps, 230.4Kbps (default rate)
- Signal Delay (electrical interface): 7bit
- constant voltage 1000V
- Resistor: without terminal resistor, connect external when necessary

#### Optical Interface

- Wave length: multi-mode 850nm、1310 nm; single mode 1310 nm、1550nm
- Fiber type: multi-mode 50/125um、62.5/125um、100/140um; single mode 8.3/125 um、9/125um、10/125um

- Transmission distance: multi-mode 2km, single mode 20km.
- Fiber interface type: ST/SC/FC (optional); ST (standard configuration).
- Single Fiber wavelength: A: Transmit wavelength is single mode 1310nm, then Receive wavelength is 1550nm; B: Transmit wavelength is single mode 1550nm, then Receive wavelength is 1310nm
- The optical line BER: <math> < 10^{-9}</math>
- Signal Delay (optical interface): <math> \leq 2.3\mu\text{s}/\text{node}</math>

**Power**

- DC (9~36V) dual redundant power input, industrial standard voltage DC24V, consumption is less than 4W, With DC1500V voltage isolation and reverse connect protection, adopt 5 cores 5.08mm industrial terminal port (please use industrial standard power, otherwise it will occur unit error or damage).

**Protection**

- Relay: optical fiber link failure and bus error alarm output
- Contact rating: 1A @24V DC, Industrial Terminal port

**Mechanical**

- Dimensions (H×D×W): 136mm×104.8mm×52.8mm
- Weight:800g
- Casing: IP40 protection, wave grain aluminum reinforce case option
- Installation: Wall mounting or DIN rail mounting

**Environmental**

- Operating Temperature: -40 °C ~75 °C (-40 °C ~85 °C optional)
- Storage Temperature: -40°C~85°C
- Ambient Relative Humidity: 5%~95%(non-condensing)

**Warranty**

- Warranty Period: 5 years

**Certifications**

- IEC61000-4-2(ESD): Power ±2KV Contact, ±8KV Air; Relay ±2KV Contact, ±8KV Air; Data Cable ±4KV Air
- IEC61000-4-4(EFT):Power ± 1KV, Data Cable ± 1KV
- IEC61000-4-5(Surge):Power ± 2KV CM/ ± 1KV DM, Relay±2KV CM/ ±1KV DM
- IEC60068-2-27(Shock)

- IEC60068-2-32(Free Fall)
- IEC61000-6-2(General Industrial Standard)
- EN50121-4 (rail transit)

**Overall Dimension**

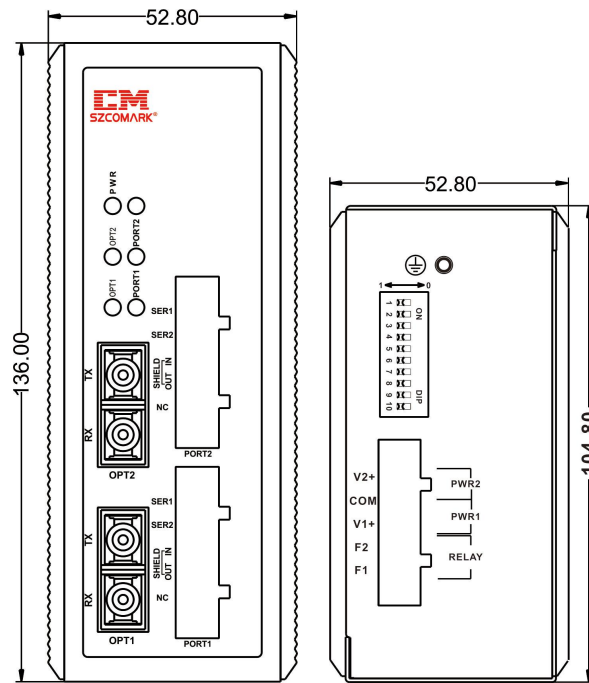

Front view

Top view

**LED Indicators**

LED	state	Description	Alarm
PWR	off	Non-connect or error	No
	Green light	Power is ok	No
	Red light	Power Error	No
OPT1-2	off	Non-connect or error	No
	Red light	The following conditions are called optical link failure: 1. No optical signal. 2. Optical port fault.	Yes
	Red shine	Optical failure, but has data sending	Yes

PORT1-2	Green light	Fiber link is normal	No
	Green shine	Fiber link is normal, have Signal	No
	off	Fieldbus is closed	No
	Red light	The following conditions are called copper link failure: 1. No data received within 2 seconds on corresponding electric port. 2. Wrong setted.	Yes
	Red shine	Electric port fault but has data sending	Yes
	Green light	Copper port is normal	No
	Green shine	Copper port is normal, can received data	No

**Terminal Resistor**

Resistor is to eliminate the effect of the signal reflected in communication cable, in Actual configuration, the Terminal resistors of the two ends of line should be on the state of "ON", the ones of intermediate node should be on the state of " OFF", otherwise, it may make communication error. Suggest to use DH+ standard connector and line.

**Connection**

1. Bus cable wiring methods: put the bus cable SER1, SER2, Shield in, Shield out as required in 5 pin terminal SER1, SER2, Shields out, shields in, and fixed the screw.
  - a) SER1/SER2, PLC or IO bus cable connector corresponding connect with optical transceiver SER1/SER2 terminals.
  - b) SHD OUT/IN relationship: SHD OUT internal connects with optical transceiver chassis ground (shielding ground), SHD IN internal connect with device chassis ground (shielding ground) trough a high voltage capacitor.

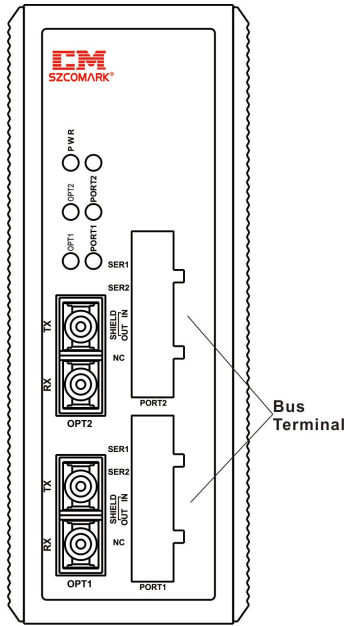

**2. Fiber connection methods:**

as shown in the figure below, the optical fiber must cross connection, namely the RX connect other side TX, and TX to RX accordingly. Ci-HF11 is one fiber port device, suitable for point-to-point connection; Ci-HF12 is dual fiber port device, suitable for bus network topology, one optical port (OPT1) to connect with front-end equipment, the other optical port (OPT2) with back-end equipment, optical fiber must cross connection.

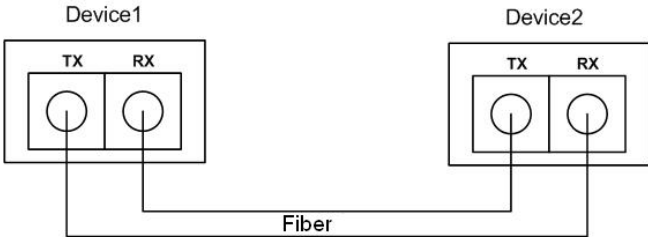

Single Fiber module(single fiber device), as shown in the figure below, single fiber can transmit and receive signal,. Note, Single fiber use 2 different wavelength to transmit and receive signal, and its paired module transmit and receive wavelength is opposite.( Device1

transmit wavelength is 1310nm, receive one is 1550nm; device2 receive wavelength is 1310nm, transmit wavelength is 1550nm.)

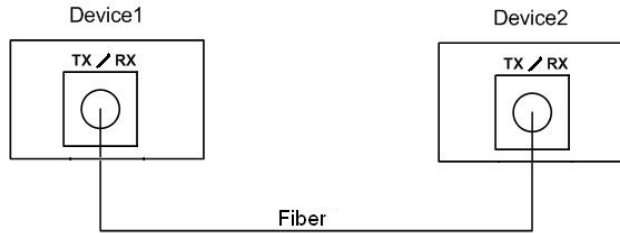

3. Power connection as shown in the figure below, this device supports dual redundant input, V1 +, V2 + respectively connect the anode of power supply (DC9 ~36V), COM with cathode (double power sharing).
4. Relay alarm output connection: F1, F2 in normal open. When the alarm is closed, make F1, F2 both contacted in series with external alarm circuit (e.g., buzzer, etc.).(When there is no electricity on device, the relay is closed.)

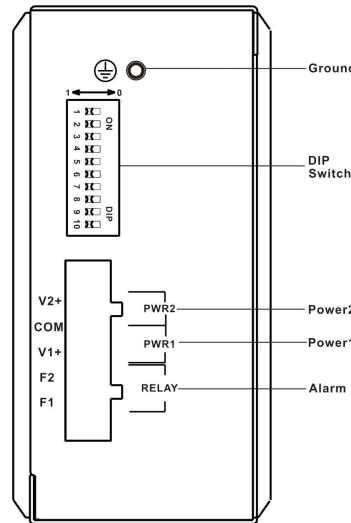

**DIN-Rail Installation**

In order to use in industrial environments expediently, Ci-HF11/12/21/22 adopt 35mm DIN-Rail installation, the installation steps as follows:

Step 1: Examine the DIN-Rail attachment

**More Reliable Connection, More Intelligent Life**

- Step 2: Examine DIN Rail whether be firm and the position is suitability or not.
- Step 3: insert the bottom of the DIN-RAIL into the slot, then insert the top of the DIN-RAIL into the slot.
- Step 4: after insert the DIN-RAIL into the slot, check the device is installed into the slot firmly.

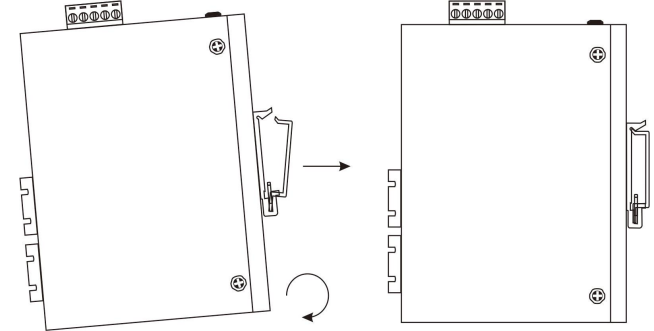

**Typical Application Point to Point**

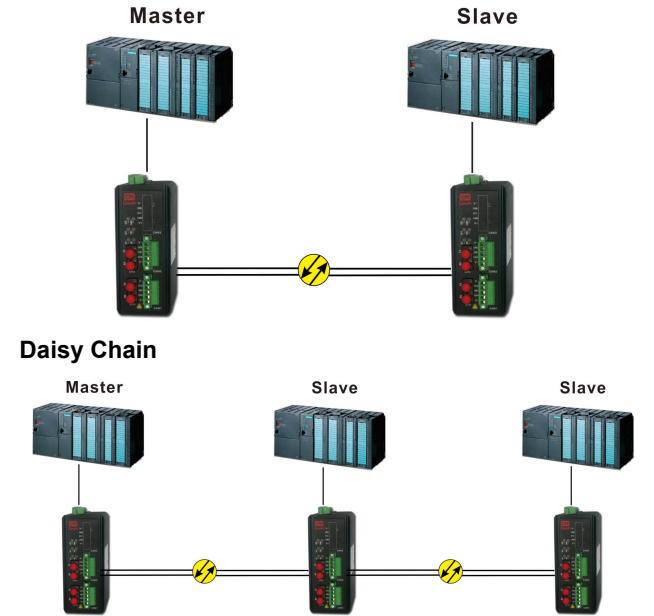

### Star Topology

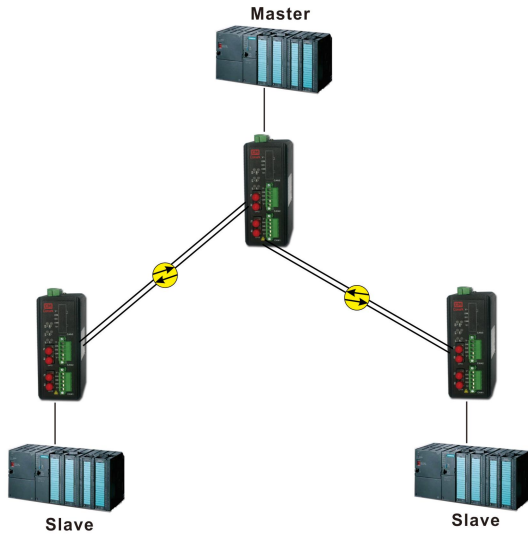

### Redundancy optical fiber ring network topology

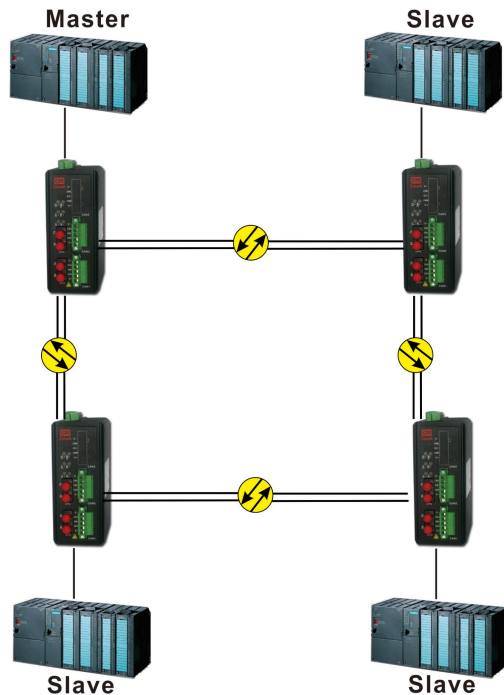

### Troubleshooting

Fault Symptoms	What to Do
PWR off	Check and ensure the power supply meets the requirement, and terminal wiring is correct or not.
PWR Red light	Device working error
OPT1~2 light	Check the fiber port connection, the length and type is correct or not.
OPT1~2 Red Shine	Check the Fiber port connection, whether the port can receive data.
PORT1~2 off	Check data of bus interface DIP switch is accord with bus rate.
PORT1~2 Red shine	Check data of bus interface DIP switch is accord with bus rate.
LED Normal, can't communicate	Check the systems time delay spec meet the fieldbus standard, please note the unit time delay addition effect, please modify PLC parameter.

### Package Checklist

Please check accessories completely when open the box.

Packing list is as follows:

- DH+ Optical Fiber Repeater (with industrial terminal block for power equipment)
- Product specification
- Product warranty card

### Cautions

- Please use DC24V Industrial standard power. Please use 0.75mm<sup>2</sup> above quality copper line.
- When relay alarm output, the voltage and current can exceed the rated one(1A@24VDC), otherwise, it will damage the unit.
- When the fiber port is not used, please use fiber cap to cover up to avoid pollute the fiber port.
- Please don't look the device fiber transmit port directly, avoid the light damage eyes.
- This device is precision communication instruction, please insure its ground connection well, the device ground connection is via the landing screw on the sideboard, please use the professional landing line, which is less than 2.5 mm<sup>2</sup>, and landing resistor is

less than 50hms.

### Order Information

Part No.	Product series	Description
Ci-HF 11	1*copper,1*Fiber	A-B DH&DH+&Remote I/O fiber-ring optic repeater, 57.6Kbps,115.2Kbps,230.4Kbps(default rate) baud rate , A-B DH&DH+&Remote I/O field bus standard, one electric port and one fiber port, 35mmDIN, Alert relay, MM/SM, ST/SC/FC optional.
Ci-HF 12	1*copper,2*Fiber	A-B DH&DH+&Remote I/O fiber-ring optic repeater, 57.6Kbps,115.2Kbps,230.4Kbps(default rate) baud rate , A-B DH&DH+&Remote I/O field bus standard, one electric port and two fiber port, 35mmDIN, Alert relay, MM/SM, ST/SC/FC optional.
Ci-HF 21	2*copper,1*Fiber	A-B DH&DH+&Remote I/O fiber-ring optic repeater, 57.6Kbps,115.2Kbps,230.4Kbps(default rate) baud rate , A-B DH&DH+&Remote I/O field bus standard, two electric port and one fiber port, 35mmDIN, Alert relay, MM/SM, ST/SC/FC optional.
Ci-HF 22	2*copper,2*Fiber	A-B DH&DH+&Remote I/O fiber-ring optic repeater, 57.6Kbps,115.2Kbps,230.4Kbps(default rate) baud rate , A-B DH&DH+&Remote I/O field bus standard, two electric port and two fiber port, 35mmDIN, Alert relay, MM/SM, ST/SC/FC optional.

**Attached List** (Ci-HF series Baud rate switch set)

SW	Function
S1	=1(default) enable OPT1 Fiber port alarm output =0 disable OPT1 Fiber port error alarm output
S2	=1(default) enable OPT2 Fiber port alarm output =0 disable OPT2 Fiber port error alarm output
S3...S6	0111 set PORT1 bus rate as 57.6Kbps. 0101 set PORT1 bus rate as 115.2Kbps. 0011 set PORT1 bus rate as 230.4Kbps.
S7...S10	0111 set PORT2 bus rate as 57.6Kbps. 0101 set PORT2 bus rate as 115.2Kbps. 0011 set PORT2 bus rate as 230.4Kbps.

**Notes:**PORT1, PORT2 rate can be set to difference.